

WorkMaster Linear

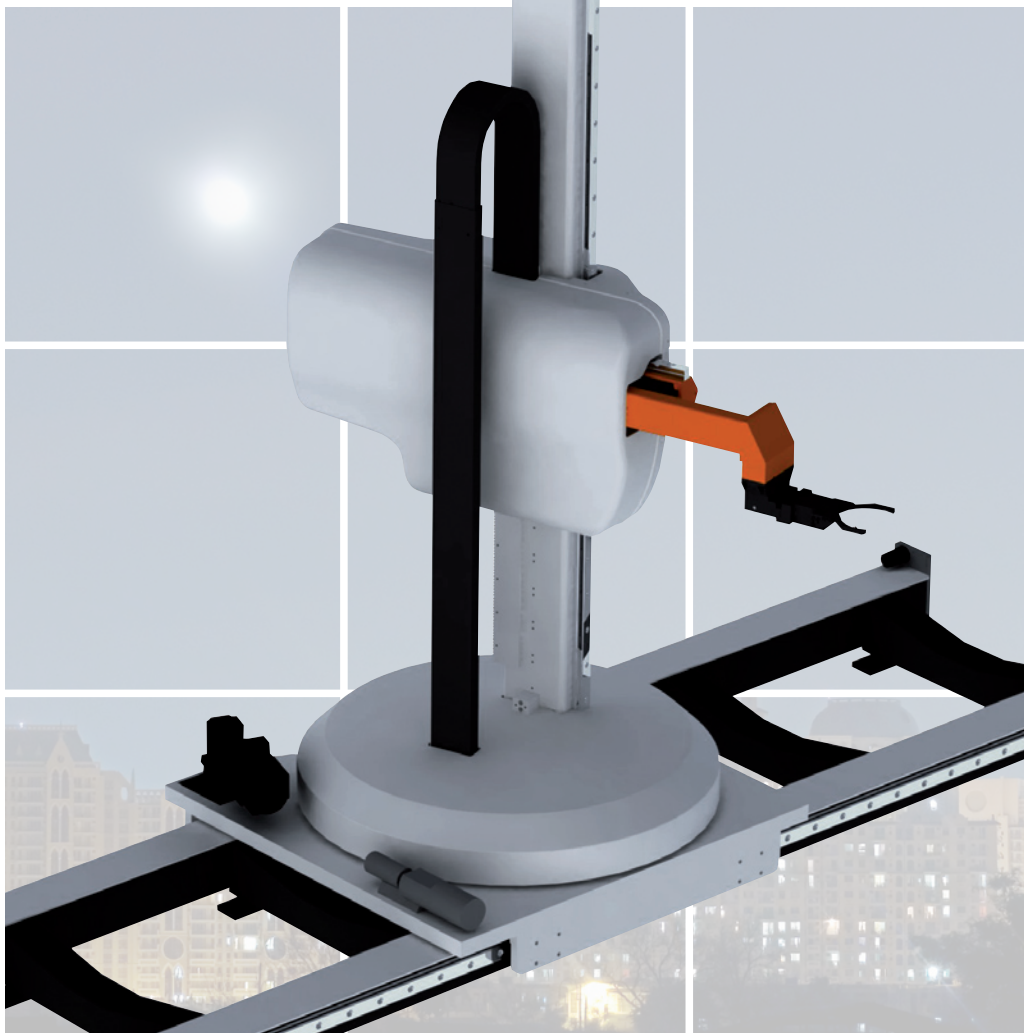

WORKMASTER LINEAR

is an automation concept that gives extreme flexibility. By placing WorkMaster on rails, the changer unit can be made to serve a large number of machines, and at the same time more space is created for magazines and peripherals.

Several designs of magazine are available. The basic variants are modular racks or rotating magazines, where the shelves are matched to the pallet systems in System 3R's wide range of products.

Typical fields of application are:

- ▶ milling – changing of workpiece and cutting tool
- ▶ grinding – changing of workpieces
- ▶ die-sinking EDM – changing of workpieces and electrodes
- ▶ wire EDM – changing of workpieces

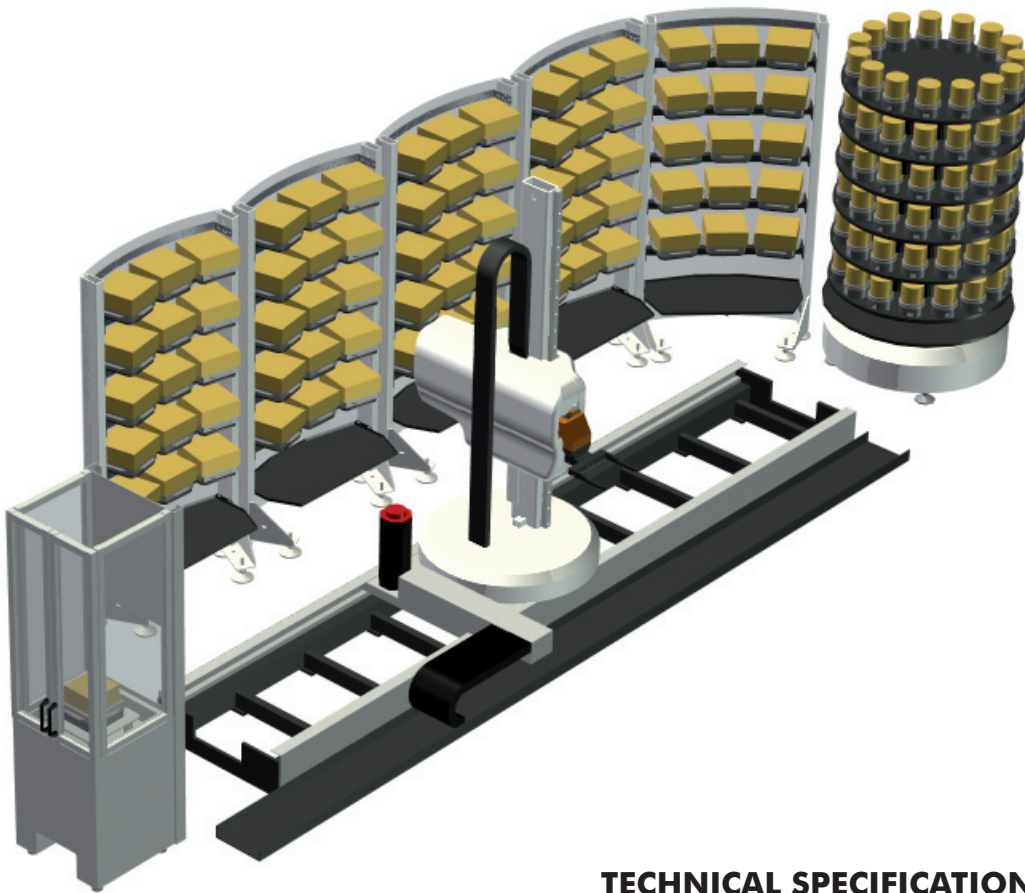

TECHNICAL SPECIFICATION

- Transfer weight – pallet with workpiece 75 kg or 150 kg, electrodes 10 kg
- X-, Z- and C-axes – AC servomotor
- Linear axis – AC servomotor
- Max stroke, X-axis, 1250 mm
- Stroke, Z-axis – 1400 mm
- Rotation, C-axis, 300 degrees
- Linear axis motion – 4 to 20 metres
- Power supply required: three-phase 400 V AC, 3.5 kVA
- Air pressure required – 6 ± 1 bar, 150 l/min
- Interface - serial R232/422, M-function or parallel I/O
- ▶ Option – ID system with/without automatic scanning

CONFIGURATION EXAMPLE

Production cell with several machining technologies. Milling, die-sinking EDM and measurement. The cell is monitored by CellManager for assured process security.

- Milling machines
- Die-sinking EDM machines
- Measuring machine
- Rack magazine
- Rotary magazine
- Preparation station
- Washing station

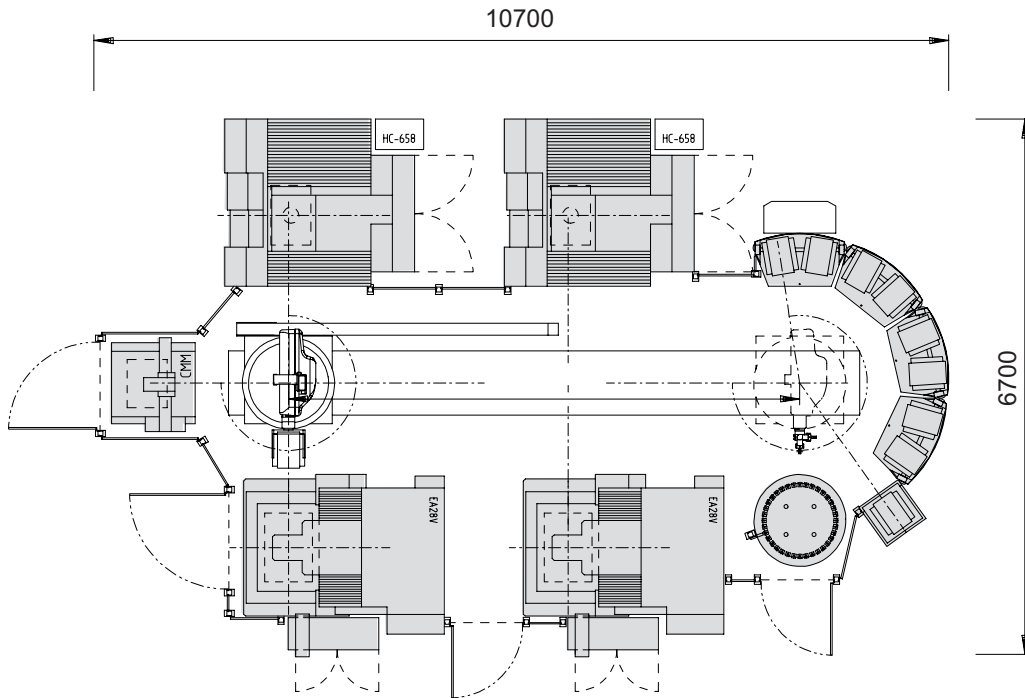

Milling cell

- Milling machines
- Measuring machine
- Rack magazine
- Preparation station

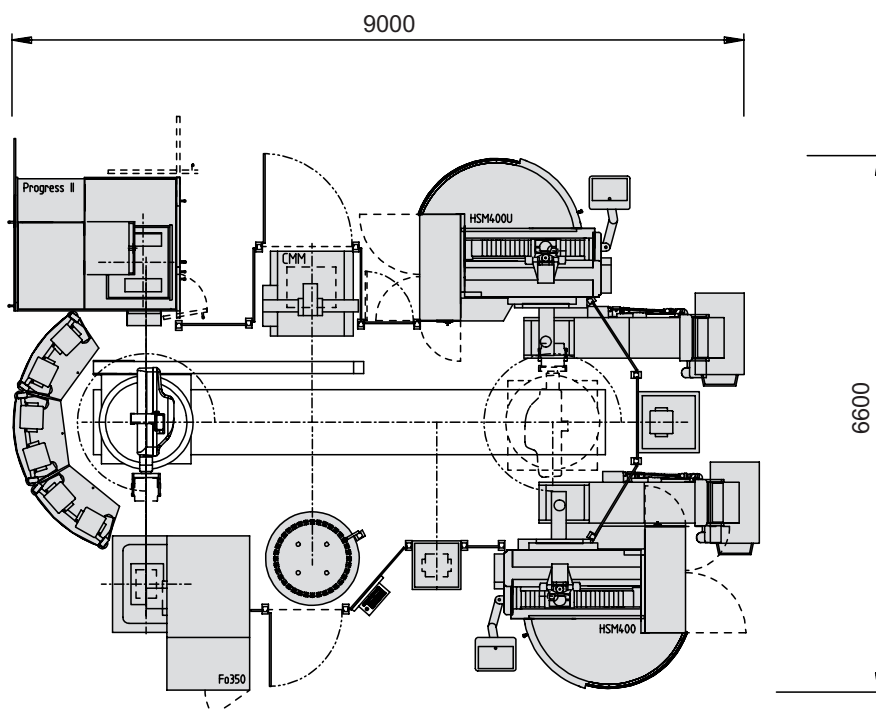

MODULAR MAGAZINES GIVE FLEXIBILITY

The magazines are available in two basic designs – rack or rotary. In both cases they are matched to System 3R's pallet system. Each magazine unit consists of a number of shelves. The number is determined by the height of the workpieces in

question. Because of the modular design, you can start with fewer pallet positions. When the need arises, you can add one or more magazine units to increase the production capacity in step with the growth of your business.

Half rack magazine

- Five levels
- Maximum load per level – 150 kg
- Maximum total load – 1200 kg
- ▶ Option – door for loading from behind
- ▶ Option – more shelves

Tool system	Number of positions per shelf	Maximum dimensions workpiece
GPS240	1	450 x 450 mm
Dynafix	1	450 x 450 mm
Delphin	1	450 x 450 mm
MacroMagnum	1	200 x 200 / Ø200 mm



Full rack magazine

- five levels (standard)
- Maximum load per level – 300 kg
- Maximum total load – 1200 kg
- ▶ Option – door for loading from behind
- ▶ Option – more shelves

Tool system	Number of positions per shelf	Maximum dimension workpiece
MacroJunior	21	45 x 45 / Ø45 mm
Macro 54 och 70	12	70 x 200 / Ø80 mm
GPS70	12	70 x 200 / Ø80 mm
Macro Ø116	6	150 x 150 / Ø160 mm
GPS120	6	150 x 150 / Ø160 mm
MacroMagnum	5	170 x 170 / Ø185 mm
GPS240	3	275 x 275 mm
GPS240	2	400 x 400 mm
Dynafix	2	400 x 400 mm
Delphin	2	400 x 400 mm

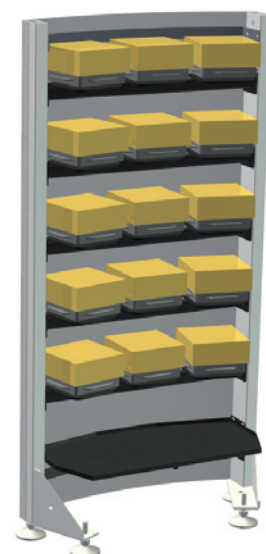

In **wire EDM**, only customer-specific solutions, since the number of positions per shelf is determined mainly by the size of the workpiece and therefore of the clamping elements and not by the tool system – whether you choose Macro, Unimatic or MacroTwin.

Rotary magazine

- Maximum total load – 1000 kg

Tool system	Number of positions per shelf	Maximum dimensions workpiece
Macro Ø116	20	135 x 135 / Ø150 mm
GPS120	20	135 x 135 / Ø150 mm
MacroMagnum	15	160 x 160 / Ø190 mm
GPS240	6	280 x 280 mm
Dynafix	6	280 x 280 mm

In **wire EDM**, only customer-specific solutions, since the number of positions per shelf is determined mainly by the size of the workpiece and therefore of the clamping elements and not by the tool system – whether you choose Macro, Unimatic or MacroTwin.



Indexing magazine

- Maximum total load – 1000 kg

Tool system	Number of positions per shelf	Maximum dimensions workpiece
MacroCombi	60	44 x 44 / Ø44 mm
Macro 54 och 70	32	65 x 65 / Ø90 mm
GPS70	32	90 x 90 / Ø95 mm

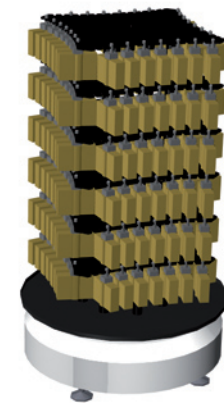

WPS – preparation station / loading station

Station for the preparation of workpieces. The station has a door and side guards. Fencing is not needed. A chuck is not included.

- Maximum workpiece dimensions – 450x450x450 mm
- Maximum load – 200 kg
- Collection tray for oil and flushing liquid
- Presence monitoring
- Prepared for chuck installation, including foot control and pneumatic connections
- ▶ Option – manual flushing liquid sensor
- ▶ Manual indexing unit, 4x90 degrees, with locking device
- ▶ D antenna, fixed

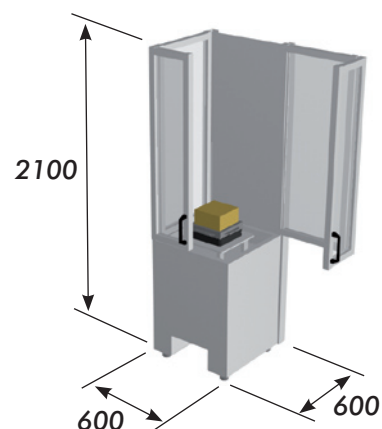

System 3R International AB

Sorterargatan 1, SE-162 50 VÄLLINGBY

tel +46-08 620 20 00, fax +46-08 759 52 34, e-mail: info@system3r.com, www.system3r.com

ASIA

Far East, China & India
System 3R Far East Pte.Ltd.
6 Harper Road
Leong Huat Building, 01-01
SINGAPORE SG-369 674
tel +65-6289 4811
fax +65-6289 3011
e-mail info.sg@system3r.com

Shanghai Contact Office
tel +86-21 6432 7927
fax +86-21 6432 7928
e-mail info.cn@system3r.com

Beijing Contact Office
tel +86-10 8225 1632
fax +86-10 8225 1635

Guangdong Contact Office
tel +86-769 8162 0628
fax +86-769 8162 0638

Malaysia Contact Office
tel +60-03 7877 4785
fax +60-03 7877 5948

Taiwan Regional Office
tel +886-02 2278 3126
fax +886-02 2278 3108

Thailand Contact Office
tel / fax +66-2 6422 764

Japan & Korea
System 3R Japan CO., Ltd.
Kaki Building
2-5-22, Suido, Bunkyo-ku
TOKYO JP-112-0005
tel +81-03 5840-7383
fax +81-03 5840-8723
e-mail info.jp@system3r.com

Nagoya Regional Office
tel +81-052 774 6250
fax +81-052 774 6285

Osaka Regional Office
tel +81-06 6396 1500
fax +81-06 6396 2855

EUROPE

System 3R Europe GmbH
Wasserweg 19
DE-64521, GROSS-GERAU
tel +49 61 52 80 02 0
fax +49 61 52 80 02 35
e-mail info.eu@system3r.com

Czech Republic & Slovakia
System 3R Czech
Tiskarska 10/257
CZ-108 28 PRAHA 10
tel +420 234 054 224
fax +420 234 054 225
e-mail info@system3r.cz

France & Portugal
System 3R France
56 Boulevard de Courcerin
Les Espaces Multiservices 15
F-77183 CROISSY BEAUBURG
tel +33-01 60 95 90 80
fax +33-01 60 37 88 16
e-mail info.fr@system3r.com

Germany & BeNeLux
System 3R Deutschland
Wasserweg 19
DE-64521, GROSS-GERAU
tel +49 61 52 80 02 0
fax +49 61 52 80 02 35
e-mail info.de@system3r.com

Italy & Spain
System 3R Italia
Via Ponchielli, 2/4
IT-20063 CERNUSCO SUL NAVIGLIO (MI)
tel +39 02 92 38 821
fax +39 02 92 11 23 19
e-mail info.it@system3r.com

Scandinavia
System 3R Nordic
Sorterargatan 1
SE-162 50 VÄLLINGBY
tel +46-08 620 20 00
fax +46-08 38 81 84
e-mail info.no@system3r.com

Järfälla Hårdverkstad
Elektronikhöjden 8
SE-175 43 JÄRFÄLLA
tel +46-08 580 125 50
fax +46-08 580 126 55
e-mail info@jvh.se

Switzerland & Austria
System 3R Schweiz AG
Wilerstrasse 98
CH-9230 FLAWIL
tel +41-071 394 13 50
fax +41-071 394 13 60
e-mail info.ch@system3r.com

Turkey & Bulgaria
System 3R Türkiye
Abdi Ipekci Cad. Ozel Idare Is Merk 150/209
Bayrampasa 34030 ISTANBUL
tel +90-212 613 8062-8063
fax +90-212 613 8069
e-mail system3r@superonline.com

United Kingdom
System 3R UK
Redvale House, New Road
PRINCES RISBOROUGH, Buckinghamshire
HP27 0JN United Kingdom
tel +44-01844 27 44 55
fax +44-01844 34 88 00
e-mail info.uk@system3r.com

AMERICA

System 3R USA Inc.
Headquarters & Technical Center
915 Busse Road
ELK GROVE VILLAGE, US-IL 60007
tel +1 847 439 4888
fax +1 847 439 5099
e-mail: info.us@system3r.com

Canada & Eastern MI
116 Lynngate Place
London Ontario Canada N6k
1S5
Canada
tel +1 519 870 8339, +1 248 320 1016
e-mail: ted.bilous@system3r.com

*AZ, CA, CO, ID, MT, NM, NV, OR, TX,
UT, WA, WY & Mexico*
1241 Celery Lane
Corona, US-CA 91719
Tel +1 909 226 1042
e-mail: ben.avila@system3r.com
1524 Valley Dr.
Norco, US-CA 92860
tel +1 714 299 4923
e-mail: dennis.vanhine@system3r.com

IA, MN, ND, NE, SD & WI
915 Busse Road
Elk Grove Village, US-IL 60007
tel +1 847 439 4888, +1 630 240 9825
fax +1 847 439 5099
e-mail: dan.pilolla@system3r.com

AR, IN, KY, OH & TN
8466 Hill Pine Court
Indianapolis, US-IN 46227
tel +1 317 215 4039, +1 317 694 7508
fax +1 317 215 4041
e-mail: jim.norcross@system3r.com

AL, FL, GA, LA, MS, NC & SC
20934 Orchard Town Ave.
Land O Lakes, US-FL 34638
tel +1 813 326 0125
e-mail: reuben.romney@system3r.com

IL, KS, MO, OK & Western MI
915 Busse Road
Elk Grove Village, US-IL 60007
tel +1 847 439 4888, +1 630 240 9824
fax +1 847 439 5099
e-mail: anders.utterstrom@system3r.com

NJ, NY & PA
67 Forest Drive
Pompton Plains, US-NJ 07444
tel +1 201 248 3885
e-mail: frank.johnson@system3r.com

*CT, DC, DE, MA, MD, ME, NH, RI, VA,
VT & WV*
915 Busse Road
Elk Grove Village, US-IL 60007
tel +1 847 439 4888, +1 201 214 7088
fax +1 847 439 5099
e-mail: jack.sebzda@system3r.com